





FPGWORLD.COM

IMPULSE SLIM



16H 06W
OPEN FRONT/4 SHELVES
REFRIGERATED: R290 **VSD**

RANGE	IMPULSE SERIES
TEMPERATURE	REFRIGERATED
MODEL	IN-VI06-R-16-05-B1xx
FRONT	OPEN FRONT
INSTALLATION	FREESTANDING/ROLLERS
REFRIGERATION	INTEGRAL, R290
TECHNOLOGY	VARIABLE SPEED DRIVE (VSD)
HEIGHT	1600mm
WIDTH	600mm
DEPTH	466mm

CORE PRODUCT TEMPERATURE	+2°C - +4°C
ENVIRONMENTAL TEST CONDITIONS	CLIMATE CLASS 3 25°C / 60% RH
CABINET CLASSIFICATION	3M1

ENERGY EFFICIENCY	
NZ & AU  4 ENERGY RATING For Star Rating, please visit reg.energyrating.gov.au/comparator	EU For EPREL Rating, please visit:  





FEATURES

-  **Very high energy efficiency: 0.43 kWh per hour (average)**
-  **Maintains an average of +2°C - +4°C core product temperature at Climate Class 3: 25°C/60%RH**
- Compact open front display, powdercoated satin black for a sleek finish

Open Front Refrigerated Display

- Five display levels: four height adjustable shelves and base are powdercoated black with textured stipple finish and full cabinet width to support maximum display capacity
-  Pluggable 50,000 hour LED lighting system at 800 lumens per metre in cabinet top, each shelf and to base
- Shelf and base ticket strips: 30mm

Operational Excellence

-  Constructed from stainless steel and powdercoated mild steel with fully double-glazed, low-E coated, toughened safety glass for maximum energy efficiency, climate control and durability
-  Fitted with high capacity EC (electronically controlled) energy saving and low noise fans
-  Variable speed drive inverter compressor and electronic controller ensure the cabinet is operating as efficiently as possible
-  Cabinet features an 'air curtain' to retain cold air within cabinet
-  Configured with a pre-filter - with weekly cleaning by operations staff the life of the cabinet can be extended
- Auto Condensate Removal (ACR)
- Fitted with unidirectional rollers



Showing : Impulse Slim 16H 06W refrigerated freestanding open front with four shelves and base

OPTIONS & ACCESSORIES

Contact a [FPG Sales Representative](#) for our full range, including:

- Add/remove shelves
- Shelf: Colour and woodprint options available
- Custom colour
- Branded decals
- Lockable castors
- Night curtain
- Swing doors



Please contact FPG to discuss your requirements for meeting country-specific standards.

FPGWORLD.COM

REFRIGERATION DATA

MODEL	CORE PRODUCT TEMPERATURE	ENVIRONMENTAL TEST CONDITIONS	REFRIGERATION	REFRIGERANT	A LIMIT	CONDENSATE REMOVAL
IN-VI06-R-16-05-B1xx	+2°C - +4°C	Climate Class 3 - 25°C / 60% RH	Integral - VSD	R290	N/A	ACR

ELECTRICAL DATA

MODEL	VOLTAGE	PHASE	CURRENT	E24H (kWh)	kWh per hour (average)	IP RATING	MAINS		LED LIGHTING		
							CONNECTION	CONNECTION PLUG ¹	HOURS	LUMENS per metre	COLOUR
IN-VI06-R-16-05-B1xx	220-240 V	Single	5.6 A	10.27	0.43	IP 21	3 metre 3 core cable	10 amp 3 pin plug	50,000	800	Natural

¹Please advise country to change plug specification.

CAPACITY, ACCESS & CONSTRUCTION

MODEL	SHELF DISPLAY AREA	LEVELS	ACCESS FRONT	ACCESS REAR	CHASSIS CONSTRUCTION
IN-VI06-R-16-05-B1xx	0.62 m ²	4 Shelves + Base	Open front	N/A	Mild steel and double-glazed safety glass

DIMENSIONS

MODEL	H x W x D mm (Uncrated)	MASS (Uncrated)
IN-VI06-R-16-05-B1xx	1600 x 600 x 466	119 kg

Crated weights and dimensions vary. Please contact us for information on your shipment.

Installation note: Designed to be installed as a stand alone unit or in an island matrix. Please request a thermal film when installing a refrigerated cabinet next to an adjacent refrigerated cabinet. **UNOBSTRUCTED AIRFLOW MUST BE MAINTAINED TO ENSURE UNIT PERFORMANCE AND TO MAINTAIN WARRANTY. WHEN PLACED AGAINST A WALL OR IN AN ISLAND MATRIX AIRFLOW VENTING IS RE-DIRECTED TO TOP OF CABINET. ALLOW NO LESS THAN 200mm CLEARANCE ABOVE CABINET FOR AIRFLOW.**

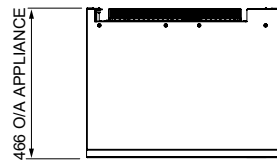

PLAN VIEW

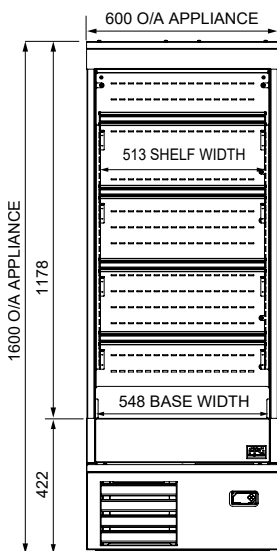

FRONT ELEVATION

WHEN PLACED AGAINST A WALL OR IN AN ISLAND MATRIX AIRFLOW VENTING IS RE-DIRECTED TO TOP OF CABINET. ALLOW AIRFLOW CLEARANCE OF 200mm.

REAR BOTTOM VENTILATION
AIR OUTLET

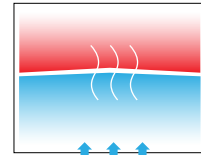

PLAN VIEW - AIRFLOW

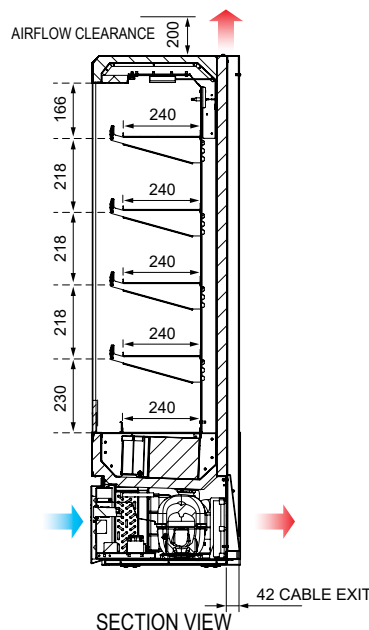

SECTION VIEW

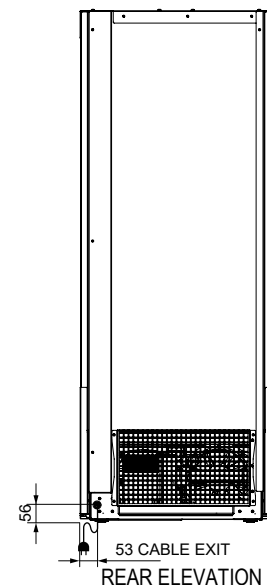

REAR ELEVATION

For information on technical data and installation guidelines please contact support@fpgworld.com

In line with our policy to continually develop, improve and support our products, Future Products Group Ltd reserves the right to change specifications and design without notice.

Have a question? Please email us at sales@fpgworld.com or visit www.fpgworld.com for full contact details for your region.

