





FPGWORLD.COM

ENCORE



SERIES 8 OPEN FRONT 1200 SQUARE/ON-COUNTER/2 SHELVES REFRIGERATED: R290 VSD

RANGE	ENCORE SERIES 8 OPEN FRONT
TEMPERATURE	REFRIGERATED
MODEL	IN-EC12-R-OF-08-B105
FRONT	SQUARE/OPEN FRONT
INSTALLATION	ON-COUNTER
REFRIGERATION	INTEGRAL, R290
TECHNOLOGY	VARIABLE SPEED DRIVE (VSD)
HEIGHT	1260mm
WIDTH	1200mm
DEPTH	662mm



CORE PRODUCT TEMPERATURE	+1°C - +3°C
ENVIRONMENTAL TEST CONDITIONS	CLIMATE CLASS 3 25°C / 60% RH
CABINET CLASSIFICATION	3M0

ENERGY EFFICIENCY	
<p>NZ & AU</p>  <p>ENERGY RATING</p> <p>For Star Rating, please visit reg.energyrating.gov.au/comparator</p>	<p>EU</p> <p>For EPREL Rating, please visit:</p>  





FEATURES

-  **High energy efficiency: 0.80 kWh per hour (average)**
-  **Maintains an average of +1°C - +3°C core product temperature at Climate Class 3: 25°C/60%RH**
- Smart display with double-glazed glass finished with a black trim

Open Front Refrigerated Display

-  Two height-adjustable stainless steel shelves and base are full cabinet width to support maximum display capacity
-  50,000 hour LED lighting system at 1500 lumens per metre in cabinet top and to each shelf
- Unique front ticket strip holders 30mm on shelves and base, and to the rear of shelves

Operational Excellence

-  Sliding doors (staff side) and open front (customer side)
-  Constructed from stainless and mild steel with fully double-glazed, low-E coated, toughened safety glass for maximum energy efficiency, climate control and durability
-  Variable speed drive inverter compressor and electronic controller ensure the cabinet is operating as efficiently as possible
-  Configured with a pre-filter - with regular cleaning by operations staff the life of the cabinet can be extended
- Auto condensate removal (ACR)
- FPG Freeflow air ventilation at rear eliminates the need for front ventilation panels
- Designed to be installed into joinery



Showing : Encore Series 8 Open Front refrigerated 1200mm square on-counter with integral refrigeration

OPTIONS & ACCESSORIES

Contact a [FPG Sales Representative](#) for our full range, including:

- Shelf trays: glass or mild steel. Powdercoat colour and woodprint options available for steel.
- Branded decals
- Base & shelf ticket strips: powdercoat colour
- Forward-facing controls
- Sides: mirror effect
- Rear Sling Doors that slide and swing
- Pull-out shelves
- Thermal film
- Night curtain
- Custom joinery solution



Please contact FPG to discuss your requirements for meeting country-specific standards.

FPGWORLD.COM

REFRIGERATION DATA

MODEL	CORE PRODUCT TEMPERATURE	ENVIRONMENTAL TEST CONDITIONS	REFRIGERATION	REFRIGERANT	A LIMIT	CONDENSATE REMOVAL
IN-EC12-R-OF-08-B105	+1°C - +3°C	Climate Class 3 - 25°C / 60% RH	Integral - VSD	R290	10.53 m ²	Automatic

ELECTRICAL DATA

MODEL	VOLTAGE	PHASE	CURRENT	E24H (kWh)	kWh per hour (average)	IP RATING	MAINS		LED LIGHTING		
							CONNECTION	CONNECTION PLUG ¹	HOURS	LUMENS	COLOUR
IN-EC12-R-OF-08-B105	220-240 V	Single	9.3 A	19.16	0.80	IP 21	3 metre, 3 core cable	10 amp, 3 pin plug	50,000	1500 per metre	Natural

¹Please advise country to change plug specification.

CAPACITY, ACCESS & CONSTRUCTION

MODEL	SHELF DISPLAY AREA	LEVELS	ACCESS FRONT	ACCESS REAR	CHASSIS CONSTRUCTION
IN-EC12-R-OF-08-B105	1.30 m ²	2 Shelves + Base	Open front	Sliding doors	Stainless 304 and mild steel

DIMENSIONS

MODEL	H x W x D mm (Uncrated)	MASS (Uncrated)
IN-EC12-R-OF-08-B105	1260 x 1200 x 662	184 kg

Crated weights and dimensions vary. Please contact us for information on your shipment.

Installation note:

Model cutout dimensions: IN-EC12-R-OF-08-B105 models require 876 x 644mm benchtop cutout. (see product manual for installation guide). Please request a thermal film when installing a refrigerated cabinet next to an adjacent refrigerated, controlled ambient, or ambient cabinet. **UNOBSTRUCTED AIRFLOW MUST BE MAINTAINED TO ENSURE UNIT PERFORMANCE AND MAINTAIN WARRANTY.**

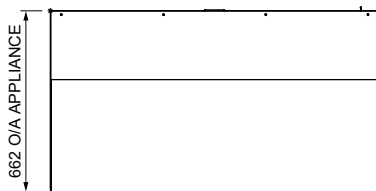

PLAN VIEW

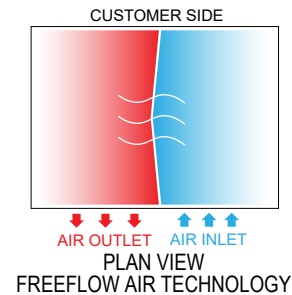

PLAN VIEW
FREEFLOW AIR TECHNOLOGY

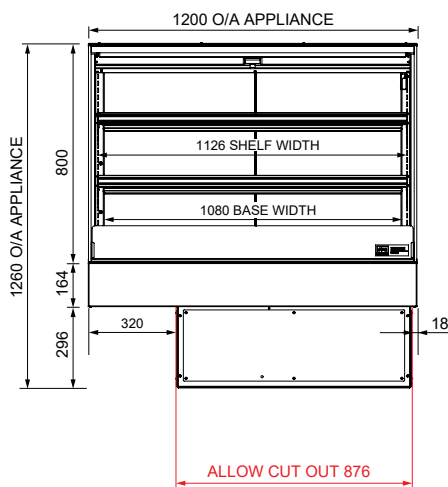

FRONT ELEVATION

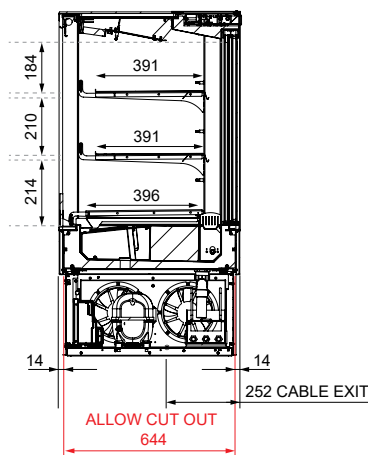

SECTION VIEW

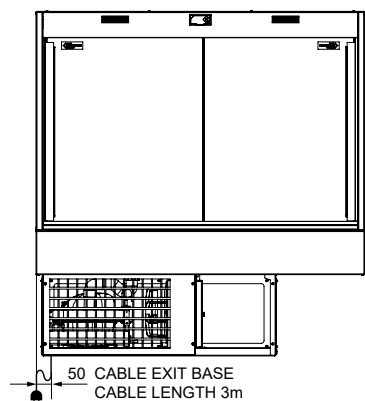

REAR ELEVATION

For information on technical data and installation guidelines please contact support@fpgworld.com

In line with our policy to continually develop, improve and support our products, Future Products Group Ltd reserves the right to change specifications and design without notice.

Have a question? Please email us at sales@fpgworld.com or visit www.fpgworld.com for full contact details for your region.

