



FPGWORLD.COM

INLINE

4000 SERIES 1200 ON-COUNTER/CURVED HEATED



RANGE	INLINE 4000 SERIES	
TEMPERATURE	HEATED	
MODEL	IN-4H12-CU-FF-OC	IN-4H12-CU-SD-OC
FRONT	CURVED/ FIXED FRONT	CURVED/ SLIDING DOORS
INSTALLATION	ON-COUNTER	
HEIGHT	993mm	
WIDTH	1203mm	
DEPTH	774mm	

TEMPERATURE RANGE	+30°C - +90°C
RECOMMENDED CORE PRODUCT TEMPERATURE	+65°C - +80°C
ENVIRONMENTAL TEST CONDITIONS	22°C / 65% RH



FEATURES

-  **High energy efficiency: 1.10 kWh per hour (average)**
-  **Cabinet operating temperature range +30°C - +90°C**
Recommended core product temperature +65°C - +80°C
- Smart display with toughened safety glass encased in brushed stainless steel frame

Fixed Front or Sliding Doors Heated Display

-  Three tiltable, height-adjustable stainless steel wire rack shelves are full cabinet width to support maximum display capacity
-  25,000 hour LED lighting system at 2758 lumens per metre in cabinet top and shelves
- Unique shelf mounted ticket strip front and rear: 30mm
- Extrusions at the top and bottom of the cabinet - front only - are fitted with stainless steel panels that can be replaced with branded inserts

Operational Excellence

-  Sliding doors (staff side) and fixed front or sliding doors options (customer side)
-  Constructed from stainless and mild steel with toughened safety glass and double-glazed end panels for maximum energy efficiency, climate control and durability
-  Low wattage density element provides even temperature distribution
- Positioned on counter top



Showing : Inline 4000 Series heated 1200mm curved on-counter with fixed front

OPTIONS & ACCESSORIES

Contact a [FPG Sales Representative](#) for our full range, including:

- Shelf trays: Toughened safety glass or mild steel
Colour and woodprint options available for steel shelf trays
- Stainless steel product trays with sides
- Stainless steel pie chutes
- Additional shelf
- Ticket strip to base: 30mm
- Branded decals/insert
- Rear door or end glass mirror application
- Forward-facing controls
- Custom joinery solution



Please contact FPG to discuss your requirements for meeting country-specific standards.

FPGWORLD.COM



FPGWORLD.COM

INLINE

4000 SERIES 1200 ON-COUNTER/CURVED HEATED

HEATED DATA

MODEL	TEMPERATURE RANGE	RECOMMENDED CORE PRODUCT TEMPERATURE	ENVIRONMENTAL TEST CONDITIONS	HEATING
IN-4H12-CU-XX-OC	+30°C - +90°C	+65°C - +80°C	22°C / 65% RH	Low wattage density element

ELECTRICAL DATA

MODEL	VOLTAGE	PHASE	CURRENT	E24H (kWh)	kWh per hour (average)	IP RATING	MAINS		LED LIGHTING		
							CONNECTION	CONNECTION PLUG ¹	HOURS	LUMENS per metre	COLOUR
IN-4H12-CU-XX-OC	220-240 V	Single	7.2 A	26.40	1.10	IP 20	3 metre, 3 core cable	10 amp, 3 pin plug	25,000	2758 per metre	Natural

¹Please advise country to change plug specification.

CAPACITY, ACCESS & CONSTRUCTION

MODEL	DISPLAY AREA	LEVELS	ACCESS FRONT	ACCESS REAR	CHASSIS CONSTRUCTION
IN-4H12-CU-FF-OC	1.2 m ²	3 Shelves	Fixed front	Sliding doors	Stainless 304 and mild steel
IN-4H12-CU-SD-OC	1.2 m ²	3 Shelves	Sliding doors	Sliding doors	Stainless 304 and mild steel

DIMENSIONS

MODEL	H x W x D mm (Uncrated)	MASS (Uncrated)
IN-4H12-CU-XX-OC	993 x 1203 x 774	140 kg

Crated weights and dimensions vary. Please contact us for information on your shipment.

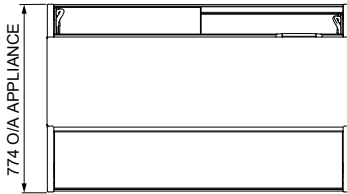

PLAN VIEW

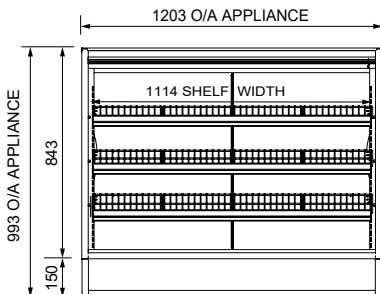

FRONT ELEVATION

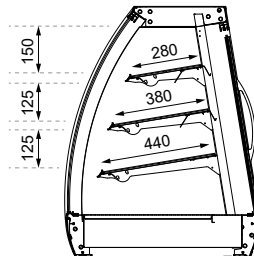

SECTION VIEW

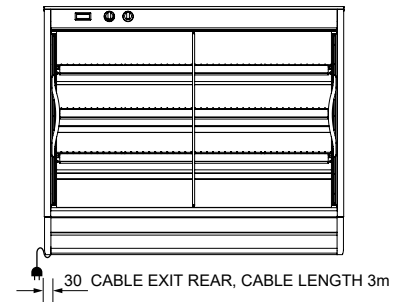

REAR ELEVATION

More information including technical data and installation guidelines is available from the Product Manual published on our website.

In line with our policy to continually develop, improve and support our products, Future Products Group Ltd reserves the right to change specifications and design without notice.

Have a question? Please email us at sales@fpgworld.com or visit www.fpgworld.com for full contact details for your region.

Worldwide
contact
details:

