



FPGWORLD.COM

# INLINE

## 3000 SERIES 1500 FREESTANDING/CURVED AMBIENT

RANGE	INLINE 3000 SERIES	
TEMPERATURE	AMBIENT	
MODEL	IN-3A15-CU-FF-FS	IN-3A15-CU-SD-FS
FRONT	CURVED/ FIXED FRONT	CURVED/ SLIDING DOORS
INSTALLATION	FREESTANDING	
HEIGHT	1261mm	
WIDTH	1503mm	
DEPTH	663mm	



CORE PRODUCT TEMPERATURE	AMBIENT
--------------------------	---------

## FEATURES



### High energy efficiency: 0.07 kWh per hour (average)

- Cabinet operating at ambient temperature
- Smart display with toughened safety glass encased in brushed stainless steel frame

### Fixed Front or Sliding Doors Ambient Display

-  Three tiltable, height-adjustable stainless steel shelves and base are full cabinet width to support maximum display capacity
-  50,000 hour LED lighting system at 2758 lumens per metre in cabinet top
- Unique shelf mounted ticket strip front and rear: 30mm
- Extrusion at the top of the cabinet - front only - is fitted with a stainless steel panel that can be replaced with a branded insert

### Operational Excellence

-  Sliding doors (staff side) and fixed front or sliding doors options (customer side)
-  Constructed from stainless and mild steel for durability with toughened safety glass and double-glazed end panels
- Fan assisted air circulation to mitigate heat build-up
- Fitted with adjustable 150mm legs (+30mm adjustment)



Showing : Inline 3000 Series ambient 1500mm curved freestanding fixed front

## OPTIONS & ACCESSORIES

Contact a [FPG Sales Representative](#) for our full range, including:

- Shelf trays: Toughened safety glass or mild steel. Colour and woodprint options available for steel shelf trays
- 50,000 hour LED lighting to shelves
- Angled base insert
- Branded decals/insert
- Rear door or end glass mirror application
- Adjustable 100mm legs (+25mm adjustment), lockable castors or unidirectional rollers
- Forward-facing controls
- Rear deck assemblies
- Thermal divider panels
- Custom joinery solution



Please contact FPG to discuss your requirements for meeting country-specific standards.

FPGWORLD.COM



FPGWORLD.COM

# INLINE

## 3000 SERIES 1500 FREESTANDING/CURVED AMBIENT

### AMBIENT DATA

MODEL	CORE PRODUCT TEMPERATURE
IN-3A15-CU-XX-FS	Ambient

### ELECTRICAL DATA

MODEL	VOLTAGE	PHASE	CURRENT	E24H (kWh)	kWh per hour (average)	IP RATING	MAINS		LED LIGHTING		
							CONNECTION	CONNECTION PLUG <sup>1</sup>	HOURS	LUMENS per metre	COLOUR
IN-3A15-CU-XX-FS	220-240 V	Single	0.31 A	1.68	0.07	IP 20	3 metre, 3 core cable	10 amp, 3 pin plug	50,000	2758 per metre	Natural

<sup>1</sup>Please advise country to change plug specification.

### CAPACITY, ACCESS & CONSTRUCTION

MODEL	DISPLAY AREA	LEVELS	ACCESS FRONT	ACCESS REAR	CHASSIS CONSTRUCTION
IN-3A15-CU-FF-FS	1.9 m <sup>2</sup>	3 Shelves + Base	Fixed front	Sliding doors	Stainless 304 and mild steel
IN-3A15-CU-SD-FS	1.9 m <sup>2</sup>	3 Shelves + Base	Sliding doors	Sliding doors	Stainless 304 and mild steel

### DIMENSIONS

MODEL	H x W x D mm (Uncrated)	MASS (Uncrated)
IN-3A0815-CU-XX-FS	1261 x 1503 x 663	- kg

Crated weights and dimensions vary. Please contact us for information on your shipment.

#### Installation note:

Model cutout dimensions: IN-3A15-CU-XX-FS models require 1508 x 668mm benchtop cutout. Joinery height 652mm (see product manual for installation guide). When installing this cabinet next to an adjacent Inline 3000 Series refrigerated cabinet, please install an Inline 3000 Series thermal divider panel (accessory) between them.

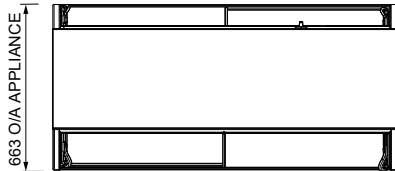

PLAN VIEW

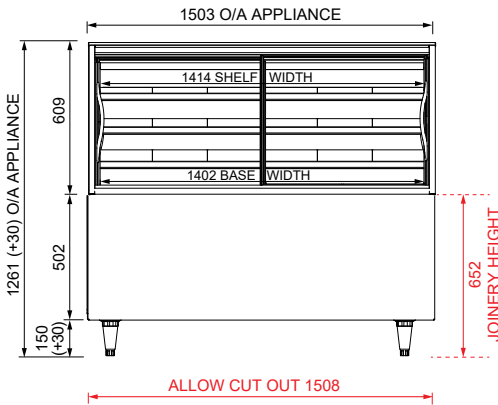

FRONT ELEVATION

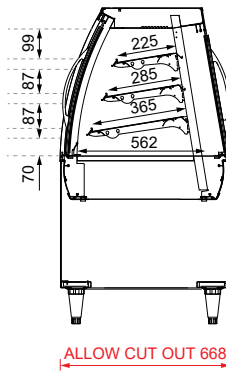

SECTION VIEW

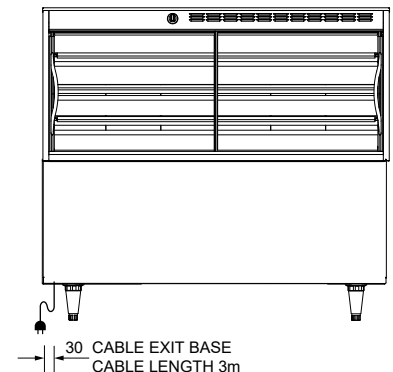

REAR ELEVATION

More information including technical data and installation guidelines is available from the Product Manual published on our website.

In line with our policy to continually develop, improve and support our products, Future Products Group Ltd reserves the right to change specifications and design without notice.

Have a question? Please email us at [sales@fpgworld.com](mailto:sales@fpgworld.com) or visit [www.fpgworld.com](http://www.fpgworld.com) for full contact details for your region.

Worldwide  
contact  
details:

