





RANGE	ISOFORM GRAB&GO
TEMP. TOP	HEATED/TILT FRONT
TEMP. BOTTOM	HEATED/OPEN FRONT
MODEL	I-GG-HH-24-14-A003
INSTALLATION	FREESTANDING
HEIGHT	1454mm
WIDTH	1208mm
DEPTH BASE	915mm

TEMPERATURE RANGE	+65°C – +80°C
RECOMMENDED CORE PRODUCT TEMPERATURE	+65°C – +80°C
ENVIRONMENTAL TEST CONDITIONS	22°C / 65% RH

FEATURES

-  **High energy efficiency: estimated 4.36 kWh per hour (average)**
-  **Cabinet operating temperature range +65°C - +80°C
Recommended core product temperature +65°C - +80°C**
- Sleek black cabinet frame with silver pinstripe (default) on front, rear and doors and grille to front panel
-  25,000 hour LED lighting system (colour: natural) at 2758 lumens per metre in both top and bottom displays



Tilt Front Heated Top Display

-  Engineered with energy-efficient, fan assisted Thermofin heating technology to provide fast heat-up time and gentle heating for extended product shelf life
- Tilt front glass provides easy access for cleaning

Open Front Heated Bottom Display

-  Two fixed **IWave** shelf is brushed stainless steel and is fitted with ticket strips front and rear: 30mm (height) with caution decal applied. Shelf is supplied with 3 x 375mm removable aluminium drip trays, powdercoated black (default)
-  FPG **IWave** heating technology uses low-wattage quartz infrared elements complemented with a heating coil in the base for even temperature distribution and extended shelf life
-  Safer for consumers - display surfaces are maintained < +65°C

Operational Excellence

-  Dual Action Doors (staff side) - doors both slide and swing for full-width access to the cabinet
-  Constructed from stainless and mild steel with fully double-glazed, toughened safety glass for maximum energy efficiency, climate control and durability
-  Fitted with an electronic controller for energy efficiency
- Fitted with unidirectional rollers and adjustable stabilisers



Showing : Isoform Grab&Go 2758mm width x 1454mm height
Top Display: Heated, tilt front. Bottom Display: Heated, open front with **IWave** shelf

OPTIONS & ACCESSORIES

Contact a [FPG Sales Representative](#) for our full range, including:

- | | |
|--|--|
| <ul style="list-style-type: none"> • Flat front panel to base • Pinstripe colour • Stainless steel product trays with three sides • Stainless steel pie chutes • Branded decals • Rear door or end glass mirror application • LED lighting colour: Warm white • Lockable castors | <p>Top Display</p> <ul style="list-style-type: none"> • Additional shelf • Shelf trays: Toughened safety glass or brushed stainless steel. Colour and woodprint options available for steel shelf trays <p>Bottom Display</p> <ul style="list-style-type: none"> • Drip trays: Colour and woodprint options available • Angled base insert |
|--|--|



HEATED DATA

	TEMPERATURE RANGE	RECOMMENDED CORE PRODUCT TEMPERATURE	ENVIRONMENTAL TEST CONDITIONS	HEATING
TOP DISPLAY	+65°C - +80°C	+65°C - +80°C	22°C / 65% RH	Fan assisted Thermofin
BOTTOM DISPLAY				IWave low-wattage infrared quartz elements

ELECTRICAL DATA

MODEL	VOLTAGE	PHASE	CURRENT	E24H (kWh)	Estimated kWh per hour (average)	IP RATING	MAINS		LED LIGHTING		
							CONNECTION	CONNECTION PLUG ¹	HOURS	LUMENS	COLOUR
I-GG-HH-24-14-A003	220-240 V	Single	32.8 A	104.64	4.36	IP 22	3 metre 3 core cable	20 amp 3 pin plug	25,000	2758 per metre	Natural

¹Please advise country to change plug specification.

CAPACITY, ACCESS & CONSTRUCTION

	DISPLAY AREA	LEVELS	ACCESS FRONT	ACCESS REAR	REAR DOORS	CHASSIS CONSTRUCTION
TOP DISPLAY	103 m ²	Base only	Tilt front	Dual Action doors	4	Stainless 304 and mild steel
BOTTOM DISPLAY	193 m ²	1 Shelf + Base	Open front	Dual Action doors	4	

DIMENSIONS

MODEL	H x W x D mm (Uncrated)	MASS (Uncrated)
I-GG-HH-24-14-A003	1454 x 2358 x 915	- kg

Crated weights and dimensions vary. Please contact us for information on your shipment.

Installation note: Designed to be installed as a stand alone unit.

Model cutout dimensions: I-GG-HH-12-14 models require 2368 x 920mm benchtop cutout. Joinery height 407mm (see product manual for installation guide).

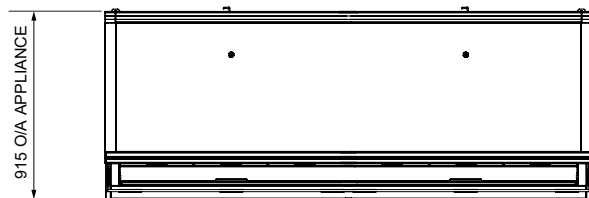

PLAN VIEW

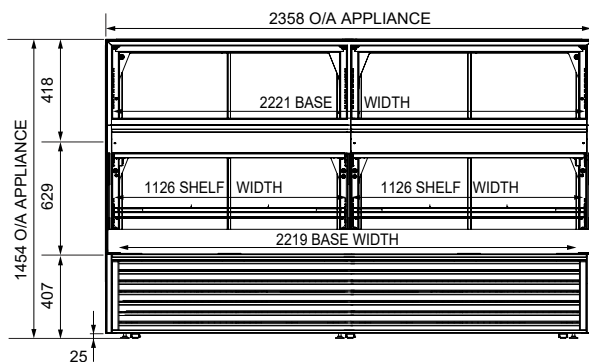

FRONT ELEVATION

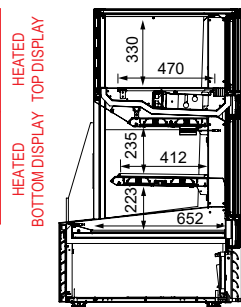

SECTION VIEW

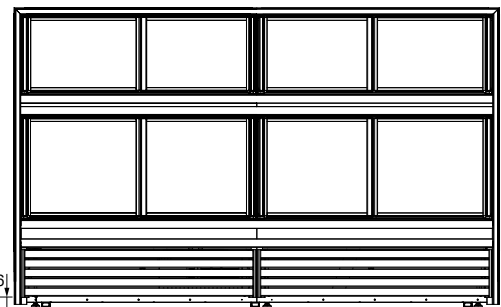

REAR ELEVATION

More information including technical data and installation guidelines is available from the Product Manual published on our website.

In line with our policy to continually develop, improve and support our products, Future Products Group Ltd reserves the right to change specifications and design without notice.

Have a question? Please email us at sales@fpgworld.com or visit www.fpgworld.com for full contact details for your region.

