

INLINE SERIES - GN MOBILE 4 PAN REFRIGERATED



MODELS

- IN-GNC04-M | GN Mobile 4 pan refrigerated, with integral condensing unit

OPTIONS [F=Factory Fitted]

- GTC-04-SS-F | Gantry with flat self serve glass (F)
- GTC-04-SS-C | Gantry with curved self serve glass (F)
- GTC-04-SO-F | Gantry with flat serve over glass (F)

ACCESSORIES [A=Accessory]

- Gastronorm dividers to hold smaller dishes (A)
- Stainless steel tray race (A)
- Gastronorm dishes, various sizes (A)

OVERVIEW

The GN Series is the ideal choice for your buffet, salad bar or refrigerated food display. With unique features such as a deep display well that holds 150mm GN pans and our three level adjustable base trays, you have the flexibility to merchandise with either GN pans or your own platters and bowls to create amazing food displays, while keeping food at a safe serving temperature. Create the ultimate flexibility with your food service displays by adding our robust stainless mobile base modules.

FEATURES

- High energy efficiency - 1.07 kWh per hour average [including gantry]
- Energy efficient moving air refrigeration system maintains +2°C - +4°C
- Irresistible food and beverage display with flexible presentation options
- Fully integral refrigeration system
- Easy to clean - cabinets can be cleaned and serviced with many parts operator removable for simple safe access
- Reversible deck pans provide ice display option
- Engineering excellence and heavy duty build quality providing years of trouble free operation
- Automatic intelligent active defrost cycle
- Best in class LED lighting with a 50, 000 hour life
- Auto condensate removal



SHOWING : GN MOBILE SERIES 4 PAN REFRIGERATED, WITH INTEGRAL CONDENSING UNIT. GANTRY WITH OPTIONAL FLAT SELF SERVE GLASS

IN-GNC04-M	ENVIRONMENTAL TEST CONDITIONS	CLIMATE CLASS 3 25°C / 60% RH	CORE PRODUCT TEMPERATURE RANGE	+2°C-+4°C
------------	-------------------------------	----------------------------------	--------------------------------	-----------

FPG refrigerated and controlled ambient food display cabinets are designed to meet and exceed:

- International safety standards for electrical appliances: IEC 60335-1, IEC 60335-2-89, and the equivalent country-specific standards including AS/NZS, BS EN and UL 471.
 - International standards for electromagnetic compatibility/emissions: CISPR 14-1, and the equivalent county-specific standards including AS/NZS CISPR and BS EN 55014-1.
 - Essential safety requirements: AS/NZS 3820 and AS/NZS 4417.
 - Energy efficiency for refrigerated appliances: MEPS (Australia/New Zealand).
- Please contact FPG to discuss your requirements for meeting country-specific standards.



FPGWORLD.COM



INLINE SERIES - GN MOBILE 4 PAN REFRIGERATED

SPECIFICATIONS

Refrigeration Data

	CLIMATE CLASS	CORE PRODUCT TEMP RANGE	REFRIGERANT	REFRIGERANT CHARGE	REMOTE CONNECTION	CONDENSATE REMOVAL
IN-GNC04-M	3 - max 25°C / 60% RH	+2°C - +4°C	R134A	See serial label	N/A	Auto/Manual*

*Option or Accessory

Please note: Remote condensing unit information; 994W @ -5°C SST & 35°C Condensing

Please note: Remote condensing unit not supplied

Electrical Data

	VOLTAGE	PHASE	CURRENT	kWh per hour [average]	MAINS CONNECTION	MAINS CONNECTION PLUG	IP RATING	ACR* POWER	ACR* CURRENT	LIGHTING
IN-GNC04-M	220-240 V	Single	4.0 A	1.0 kWh per hour	3 metre 3 core cable	10 amp, 3 pin plug	IP 22	1.0 kW	4.0A	N/A
WITH GANTRY	220-240 V	Single	4.3 A	1.7 kWh per hour	3 metre 3 core cable	10 amp, 3 pin plug	IP 22	N/A	N/A	50,000 hr LED

*ACR = Auto Condensate Removal

Display

	DISPLAY AREA	NO. OF 1/1 PANS	DISPLAY LEVELS	DRAIN DIAMETER	CONSTRUCTION
IN-GNC04-M	0.7m ²	4*	2 with 3 level adjustment	19mm	304 Stainless Steel

*Option or Accessory

Dimensions [Uncrated and Crated] with flat glass gantry

	H x W x D mm [Uncrated]*	MASS [Uncrated]*	Estimated H x W x D mm [Crated]*	Estimated MASS [Crated]*	Estimated CUBIC VOLUME [Crated]*
IN-GNC04-M	1258 x 1660 x 974	300 kg	1418 x 1734 x 1048	410 kg	2.79m ³

*Crated weights and dimensions vary depending on gantry selected. Please contact us for information on your shipment.

Installation note:

Unobstructed airflow must be maintained to ensure unit performance and maintain warranty

In line with policy to continually develop and improve it's products, Future Products Group reserves the right to change specifications and design without notice.

For more information and technical data, including installation documents, please refer to the website - www.fpgworld.com

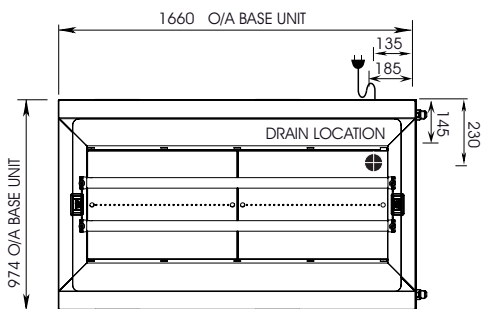

PLAN VIEW

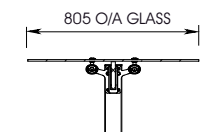
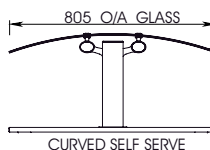
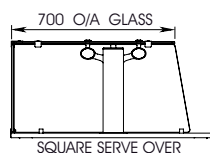

FLAT SELF SERVE

SECTION VIEW

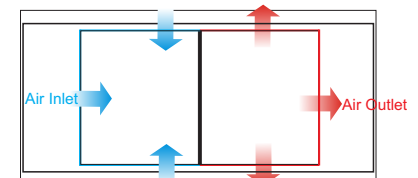

PLAN VIEW - AIRFLOW

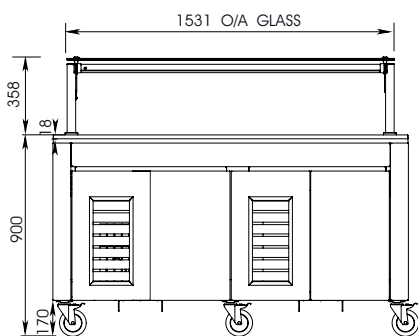

FRONT ELEVATION

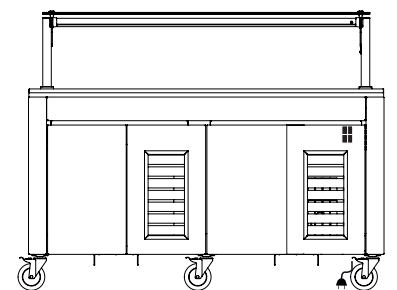

CABLE EXIT, CABLE LENGTH 3m
DRAIN LOCATION 185

REAR ELEVATION