

**ENCORE**

SERIES 8



Peak  
performer



**Trusted.  
For Life.**



Trusted.  
For Life.



BRILLIANT  
PERFORMANCE

ENCORE SERIES 8 IN-COUNTER LINE-UP REFRIGERATED & HEATED 1200  
AT BAKE SHACK, MOUNT MAUNGANUI, NEW ZEALAND

2 FPG ENCORE SERIES 8

# ENCORE

## SERIES 8

### Invest with confidence.

Encore Series 8 cabinets are peak performers.

With cabinets to cater for refrigerated, heated and ambient food, create a stunning lineup of cabinets that work harmoniously together. Enjoy the significant lifetime savings due to their superior energy efficiency.

Cabinet-wide climate control is honed perfectly to hold food and drinks for longer. Merchandise a wide variety of products with confidence.

Save on set-up costs. Replace counter joinery by adding finishing features to Freestanding cabinets: powdercoated colour, decals to the chassis, a tray race, and toe kick. Or choose In-counter or On-counter cabinets for installation in custom-made joinery.

An extensive range of modular ready-to-go options enable you to configure your Encore cabinet to meet your operational needs and wants. Request clever rear Sling Doors that slide and swing, and Pull-Out Shelves. Together they make stocking, serving, and cleaning quick and easy.

**Encore – working smarter at all levels.**



Encore Series 8 Refrigerated 1200

# OPTIONS TO SUIT YOUR BUSINESS

**Created as a flexible display solution for c-stores, cafés, and bakeries, Encore Series 8 cabinets have four display levels and a square profile.**

They are available in two popular formats to suit your customer engagement model:

- Tilt front for serve-over customer service.
- Sliding doors for self-service.

If your customer engagement model changes, no problem. You can swap out the tilt front of your cabinet with sliding doors and vice versa while the cabinets are in situ. A smart feature that maximises your cabinet investment.

Looking for an open front cabinet? See our brochure on Encore Series 8 Open Front refrigerated cabinets. They line up perfectly with Encore Series 8 tilt front and sliding door models.

TILT FRONT



CUSTOMER SIDE  
SLIDING DOORS



Create your line-up to suit your product offerings and capacity.

Encore Series 8 cabinets are available in a range of sizes and temperatures:







# OUTSTANDING PERFORMANCE

## PERFORMANCE BY DESIGN.

Guaranteed core  
product temperatures  
for the lifetime  
of the cabinet.

### Enjoy peace of mind.

All Encore Series 8 cabinets are tested in our environmental test laboratory to deliver consistent core product temperatures:

Cabinet type	Average core product temperature	Environmental test conditions
 Refrigerated	+1°C to +3°C	Climate Class 3: 25°C / 60% RH
 Controlled Ambient	+16°C to +18°C	Climate Class 3: 25°C / 60% RH
 Heated	+65°C to +80°C	22°C / 65% RH
 Ambient	Ambient	Ambient

### Gets the tick for all things electrical.

Encore Series 8 cabinets are compliant with the latest international regulations for electrical safety, electromagnetic emissions, and eco-design.



# OPTIMAL HEATED CABINETS

## Energy efficiency, temperature performance and extended shelf life.



Encore Series 8 heated cabinets and Bain Maries are designed to maximise energy efficiency and heating control through a combination of:

- Low wattage density element engineered with longer tubes to provide even gentle heating throughout the whole cabinet.
- Thermostat cycling to automatically turn the heating off/on according to temperature.
- Low-E coated double-glazed glass which provides superior insulation.
- Cabinets are fitted with four shelves to maximise shelf display area.

This means ...

**Hot food is ready to be enjoyed. Food is held safely above +65° C.**

**Extended shelf life. Product is held in better condition for longer, reducing food waste.**

**Savings. Your power bills reduce reflecting lower energy consumption.**



# SUPERIOR REFRIGERATED CABINETS

### Energy efficiency and temperature performance and extended shelf life.



Encore Series 8 refrigerated cabinets are rated up to 10 stars (Australia and New Zealand) and up to A (Europe)<sup>1</sup> for maximum energy efficiency.

They are classified 3MO with an average of +1° - +3° C for Climate Class 3.

And managed humidity levels inside the display area are as high as 80%. Outstanding!

This means ...

**Peace of mind.** They are **100% food and dairy safe.**

**Extended shelf life.** Food retains moisture and is fresher for longer.

**Savings.** Your power bills reduce reflecting lower energy consumption.

### Sustainable on-board refrigerant.

Encore Series 8 refrigerated cabinets have integral refrigeration which means they are plug and play.

We use R290 natural refrigerant which is kind to the environment and meets international regulations.

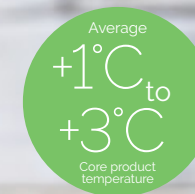

<sup>1</sup> Encore Series 8 refrigerated 600, 900 and 1200 cabinet models achieved the maximum energy ratings.

# LIGHT IT UP

**Brilliant, long life LED lighting at the top of the cabinet and under each shelf ensures your food and drinks are displayed at their best.**

With extended lifespans, lighting maintenance stays minimal while your products always look irresistible:

Refrigerated cabinets: 50,000 hours

Heated cabinets: 25,000 hours

WE  
HELP YOU  
**SELL MORE.**

Guaranteed best-in-class design that delivers unique customer experiences.



# ELEVATE YOUR BRAND

**Create a merchandising display that excels in attracting customer attention and differentiates your brand. Explore the options with FPG.**



**ATTRACT**  
WITH COLOUR

Choose custom colours for the shelves and ticket strips to complement your branding and create impact.



**WARM IT UP**  
WITH WOODPRINT

Apply woodprint to shelves to create a natural, inviting display.



**ENRICH**  
WITH MIRROR EFFECT

Mirror effect on the sides of your cabinet makes your display appear more abundant.



**ENHANCE FOOD OFFER**  
WITH BRANDING

Custom decals on freestanding cabinets boost your brand presence and create impact.

# INSTALLATION OPTIONS



## FREESTANDING

**Save money!** Configure your cabinet with options specifically designed for freestanding cabinets and eliminate the need for joinery.



## IN-COUNTER & ON-COUNTER

Request in-counter or on-counter cabinets to install your Encore Series 8 cabinet into custom-made counter joinery.

For an exceptional finish, FPG can help you with a full turnkey package.

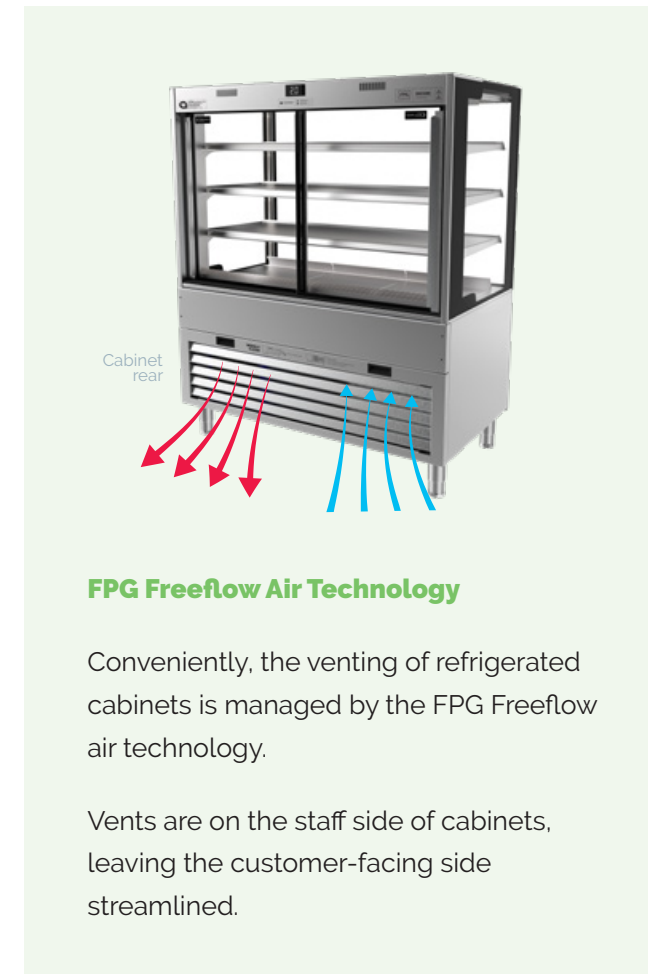

## FPG Freeflow Air Technology

Conveniently, the venting of refrigerated cabinets is managed by the FPG Freeflow air technology.

Vents are on the staff side of cabinets, leaving the customer-facing side streamlined.

# ENCORE

## SERIES 8



NO NEED  
FOR JOINERY

### ENCORE SERIES 8, FREESTANDING, TILT FRONT

L-R: REFRIGERATED 1200, CONTROLLED AMBIENT 600, HEATED 900 LINE-UP WITH OPTIONAL FEATURES - MIRROR EFFECT, BUMPER RAIL, BRANDED DECAL TO CHASSIS FRONT AND SIDES. BRANDED TICKET STRIPS AND POWDERCOATED BLACK TOE KICK.

# IMPROVE OPERATIONAL EFFICIENCY



## **UNIQUE SLING DOORS**

Upgrade rear sliding doors to FPG's innovative Sling Doors for the perfect combination of sliding convenience and full width swing access.

Stock faster, clean easier, and reduce the risk of breakage or strain.

## **CONVENIENT PULL-OUT SHELVES**

Available with Sling Doors, Pull Out Shelves transform stocking and serving efficiency, giving your team quick, ergonomic access to every shelf.

For refrigerated, controlled ambient and ambient cabinets.

# OPERATIONAL FACTORY-FITTED OPTIONS



## **FIXED REAR DECK**

Add a handy rear deck with inbuilt holder for tongs.



## **ROLLERS OR CASTORS**

If manoeuvrability is important to you, replace legs with unidirectional rollers or heavy-duty lockable castors. For Freestanding cabinets.



## **UNDER-STORAGE DRAWER**

Fitted with dividers, the under-storage drawer provides structure for holding ambient items in the under-storage area. For heated and ambient freestanding cabinets.



## **BAIN MARIE**

Bain Maries include a handy shelf and can accommodate a range of GN pan sizes.

# ELIMINATE THE NEED FOR JOINERY

**Finish your freestanding cabinet with:**



**A tray race** for self-serve cabinets fitted with sliding doors. Options include bag and tong holders.



**A bumper rail** for added protection.



Bumper rail with **product bin** to hold ambient packaged product. Optional bag and tong holder available.

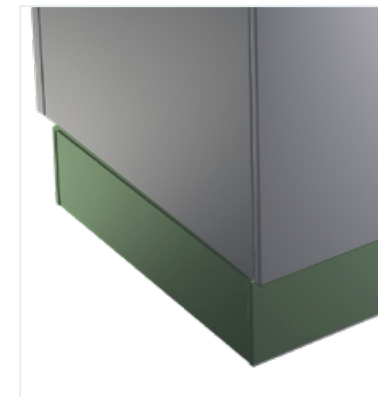

**A toe kick.**

YOUR  
**TRUSTED  
PARTNER.**

Ensuring stress-free  
experiences for our  
customers.



ENCORE SERIES 8 REFRIGERATED 1200  
WITH OPTIONAL FEATURES - BUMPER RAIL,  
COLOURED CHASSIS AND TOE KICK.

# MERCHANDISING EXCELLENCE





**Trusted.  
For Life.**



# SUSTAINABILITY

**From the outset FPG has been engineering cabinets to deliver core product temperature while optimising energy efficiency. Our cabinets help customers to use less power and to reduce their food waste by extending shelf life.**

FPG has a track record of transitioning its refrigerated cabinets to use refrigerants that are kinder to the environment; the latest transition being the uptake of organic refrigerants such as R290.

We build our cabinets to last. Using high quality components to ensure consistent reliable operation, our customers experience less business interruption. From long-life LEDs to double-glazed glass with a low-E (low-emissivity) coating for insulation, components are consciously selected to contribute to the cabinet's longevity and operational performance.

We promise to have spare parts available for as long as your cabinet is in service. And, at the end of their life, we estimate that 85% of our cabinets (by volume) can be recycled.

# TRUSTED FOR LIFE

### Extend the lifetime of your cabinet.

A few simple actions are all it takes to extend the lifetime of your cabinet and keep your warranty valid.

- Illustrated daily and weekly cleaning guidelines for operators are available from the 'How To' webpage accessed from the Service menu on the FPG website.
- For refrigerated and controlled ambient cabinets save on technical support costs. Protect the refrigeration system to ensure it runs efficiently and maintains core product temperatures by:
  - Cleaning the easy-to-access pre-filter fitted located behind the rear vents weekly.
  - Scheduling a deep clean of the condenser coil and inspection of the cabinet annually by a refrigeration technician.
- For heated and ambient cabinets, schedule an inspection of the cabinet annually by an electrical appliance technician. Keep your cabinet in tip top condition.

**BUILT  
TO LAST**

We stand by  
everything we sell  
for its lifetime.

### Cabinet warranty.

The warranty term is:

- Two years for all Encore cabinets.
- Three years for the condensing unit in refrigerated and controlled ambient cabinets.

Warranty terms and conditions are published in the cabinet manual.

### Well supported.

FPG Technical Support is available online and by phone. We publish online resources to support the technical service providers of our customers. These include 'How To' videos and comprehensive manuals.



We also offer training via online platforms and recommend the spare parts the service provider should hold locally to service the cabinets.

# STANDARDS MET

## **FPG engineers all cabinets to meet international standards.**

International safety standards for electrical refrigerated appliances:  
IEC 60335-1, IEC 60335-2-89, and the equivalent country-specific standards including AS/NZS and BS EN.

International safety standards for electrical heated appliances:  
IEC 60335-1, IEC 60335-2-49, IEC 60335-2-50 and the equivalent country-specific standards including AS/NZS and BS EN.

International standards for electromagnetic compatibility/emissions:  
CISPR 14-1, and the equivalent country-specific standards including AS/NZS CISPR and BS EN 55014-1.

Essential safety requirements: AS/NZS 3820 and AS/NZS 4417.

Energy efficiency for refrigerated appliances: MEPS (Australia/New Zealand) and EPREL (Europe)



Some countries permit self-declaration while other countries may require external testing and certificates of conformity.

**Please contact us for more information.**

**ENCORE**

SERIES 8



PEAK  
PERFORMERS

ENCORE SERIES 8 REFRIGERATED AND HEATED LINE-UP WITH OPTIONAL FEATURES - BUMPER RAIL, BLACK DECAL AND TOE KICK.

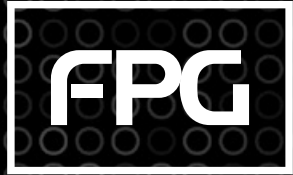

**Trusted.  
For Life.**



C-STORE



CAFÉ/BAKERY  
OSR



FMCG



HOSPITALITY



SPECIALTY  
FOOD SERVICE



SUPERMARKET

Worldwide  
contact  
details:



[fpgworld.com](http://fpgworld.com)  
[sales@fpgworld.com](mailto:sales@fpgworld.com)